

**Invest in Quality
to guide your Trajectory...**

Presenting

**WHITEOAK CAPITAL
QUALITY EQUITY FUND**

(An open ended equity scheme following Quality Factor theme)

**NFO Period:
08th - 22nd Jan, 2025**

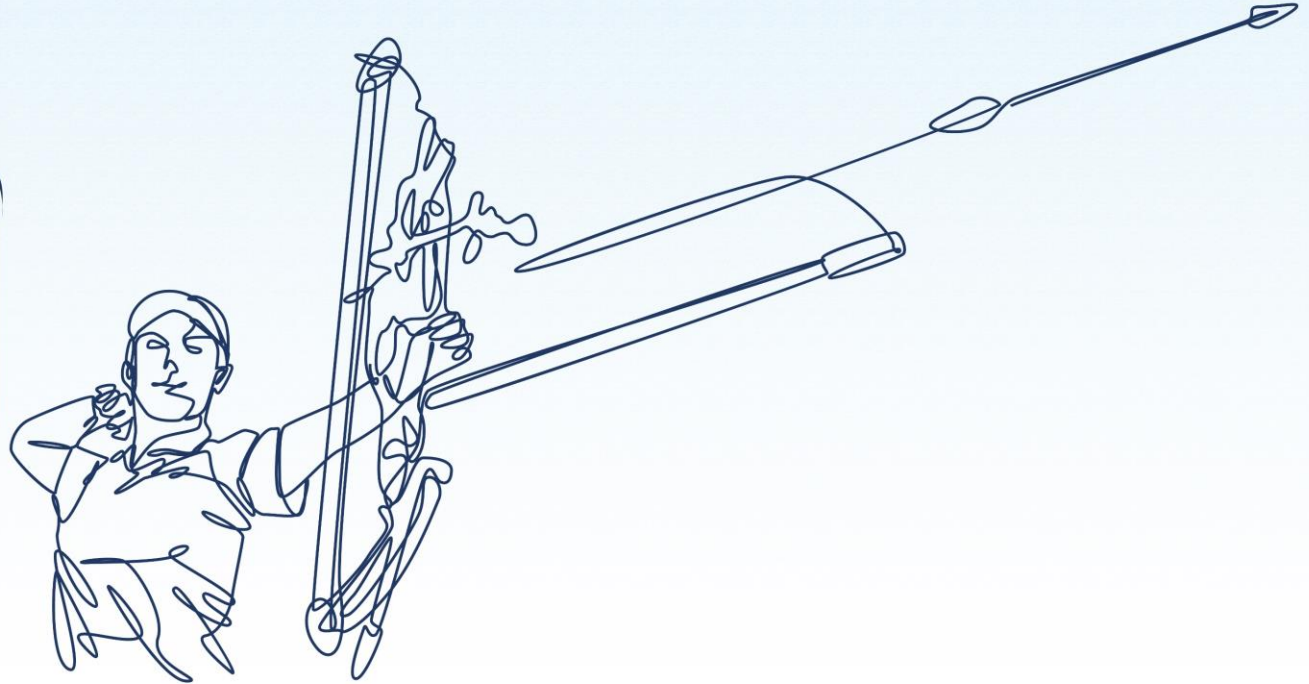

We want *Quality* in every aspect of our lives

- In our day-to-day lives, we instinctively seek quality in everything—whether it’s the durability of a car, the comfort of clothing, or the reliability of a smartphone. We understand that while quality may sometimes come at a higher price, it often pays off over time through better performance, longer life, and peace of mind.
- The same principle applies to investing. A quality stock portfolio focuses on companies with strong fundamentals—proven track records, stable cash flows, sound management, and sustainable growth prospects. Just as we choose well-made products to avoid frequent replacements or repairs, investing in quality stocks helps us avoid many of the pitfalls of investing, ensuring a smoother and more rewarding investment journey.



By prioritizing quality, whether in daily purchases or investments, we make choices that stand the test of time and deliver lasting value.

What does *Quality* mean in Investing?

The quality factor focuses on companies with strong fundamentals, signaling their ability to generate consistent earnings and withstand economic stress. Common parameters used to measure quality include **return on equity (ROE), low debt-to-equity ratio, relatively stable earnings growth, and strong free cash flow**. These criteria suggest that quality companies are financially sound and exhibit resilience, particularly during periods of market uncertainty.



For understanding purpose only. The above comments are based on what has been generally observed during various market and economic cycles under normal circumstances. However, a market cycle may coincide with various other global events such as geo-political tension etc. and hence, the performance or these factors may react differently than what has been observed under normal circumstances. Additionally, the eligibility criteria mentioned above are among the most commonly used parameters, but the list is not exhaustive. There may be many other criteria or parameters that can be used to define a particular factor.

A Leading Pharma Company



The company is leading pharmaceutical company started in 1976, which now has a dominant position in Indian Pharma Market (IPM) especially in cardiac and gastrointestinal therapies. It also boasts of a robust CMO (contract manufacturing operations) business largely focused on medicated & herbal lozenges (one of the Top3 manufacturers of Lozenges globally). It also has exports business in 40+ countries with a branded presence in Russia & South Africa.

In their India business, the company has consistently outperformed IPM growth by ~1.4x since FY10 owing to their power brand strategy, market share gains, and superior execution.

In FY21, a Private Equity bought majority stake in the Company and brought in new set of leaders. The company geared more toward diversification into newer therapeutic categories, apart from fortifying existing brands. Under the purview of new management lead by an industry veteran with 25-year-long experience, the Company doubled down on its objective of growing its India business. From ranking 32nd in the IPM at the time of the acquisition, it now ranks 22nd in the IPM.

A Mother & Child Focused Hospital Chain



The Company was founded by a Doctor in 1999 with a 50-bed pediatric hospital in Hyderabad. Today, it is a leading multi-specialty pediatric and obstetrics and gynecology hospital chain in India with presence in 6 cities with total bed capacity of 1,935 beds.

The Company is built on strong fundamentals of a multidisciplinary approach with a full-time consultant led clinical service. It has successfully executed the hub-and-spoke model at Hyderabad. This model provides patients access to multidisciplinary level 4 neonatal and pediatric intensive care and pediatric subspecialty care at the hub hospital while the spokes provide 24/7 emergency care, large outpatient services and comprehensive obstetrics, pediatric inpatient and level 3 NICU services. This model is successfully operational at Hyderabad and is gaining traction in Bengaluru. It endeavors to replicate this approach in Chennai and across the National Capital Region and subsequently expand into tier-2 cities of Southern India.

This focus on mother & child-care enables it to explore various adjacencies such as IVF and specialized retail stores within their existing hospital premises as well.



Founded in 1939 and headquartered in Kerala, the company revolutionized traditional gold lending by offering loans at competitive rates, challenging the dominance of local moneylenders and pawnbrokers. This business model capitalized on India's significant household gold reserves, giving the company a strong foundation for growth. Over the decades, company has emerged as the largest gold loan Non-Banking Financial Company (NBFC) in India, with an unwavering focus on operational excellence and customer-centric services.

With a current Asset Under Management (AUM) of ₹1,00,000 crore as of Q2FY25, company has consistently delivered superior performance, achieving an average Return on Equity (ROE) of 20% over the last 10 years and a Compound Annual Growth Rate (CAGR) of 15% in advances between FY15 and FY25E. While the company has diversified into other asset classes such as home finance, microfinance, and vehicle finance, gold loans remain its core business, contributing over 90% of its standalone AUM. Company's proven business model, operational rigor, and the vast untapped potential of India's gold market provide a strong runway for sustained growth in the years to come.

Few Examples of Quality Factor Theme Stocks

A Leading Mall Owner and Operator



The company is leading retail real estate platform with its core business involving owning and operating malls across India. Structured as a Real Estate Investment Trust (REIT), it was established in 2016 and currently has a portfolio of 17 malls across 14 cities as well as a healthy growth pipeline.

In its brief history, it has demonstrated a strong track record of acquiring underperforming assets and turning them around. This has been displayed on several occasions including the company's prime Delhi asset, Chandigarh asset as well as their malls in the South. The management's hands on execution has led to its growth outperforming its peers. It has consistently maintained occupancies above 95% on its base of ~10mn sft of assets. This has led to it delivering superior IRRs, and shorter payback period for its assets.

The REIT structure also serves as a check in avoiding capital allocation errors. REITs are mandated to distribute 90% of the net distribute cash flows, ensuring the asset cash flows accrue to minorities. All major acquisitions require minority shareholder approval and while overall leverage is capped at 49% of GAV, the company operates at only 14%.



The company is a subsidiary of Swedish – Swiss multinational company, a global technology leader in electrification and automation. The company offers a wide range of products and services, having applications across industry verticals such as data centres, electronics, railways, renewables, automobiles, etc., thereby limiting exposure to downturns in demand associated with a particular vertical. The company has transitioned from its earlier project-based business to a product and service-based business, improving operating performance.

The financial profile has significantly improved, with strong revenue growth, increased operating margins, and reduced working capital, all contributing to industry-leading pre-tax ROIC and FCF/PAT conversion of over 100% in the last financial year.

With parent oversight at the board level, the company is professionally managed, with high-quality talent and a strong, independent board. The company's electricity requirement is 100% met through renewable sources. The products supplied by the company, such as energy-efficient motors, drives, switchgear, etc., are enabling the country's energy transition with renewables (solar and wind) and hydrogen.



The company is a mid-sized IT services company with deep domain expertise in Healthcare, Hitech and Financial services. It has leveraged its rich heritage of product engineering in IT services to become one of the most credible challenger in its chosen verticals. These strengths are reflected in strong USD revenue growth of 17.3% from IPO to FY24 and industry leading 24% revenue growth in the last 4 years.

It has been able to maintain strong average FCF/PAT conversion of ~85-90% and consistent dividend payout ratio of 30-40% despite investing heavily in the business to drive growth. The business has very low financial leverage due to strong internal cashflow generation and has consistently maintained ROCE >25-30%. The company has been able to attract top leaders from Larger Tier-1 companies (including the current CEO and CFO) and Board of Directors with global experience which helps the company ensure best in class practices and execution quality.

The company has forged strong partnerships with leading enterprise software ecosystems such as Salesforce, Appian, and Snowflake which provide the company a differentiated GTM. It is expected to deliver industry leading free cashflow growth on the back of marquee deal wins, strong execution, differentiated GTM and prowess in software engineering

Few Examples of Quality Factor Theme Stocks *A Prominent Private Bank in India*



Established in 1994 as a commercial bank, it is now one of India's largest private-sector banks, offering a comprehensive suite of financial products and services, including retail banking, corporate banking, insurance, broking, and asset management. The bank is recognized for its technological innovation, having pioneered several digital-first solutions that have transformed customer experiences and set industry benchmarks.

The bank has consistently demonstrated robust financial performance, combining strong credit underwriting with prudent risk management practices. After navigating challenges in the corporate asset quality cycle during the FY16-19 period, the bank emerged stronger under able leadership. Since FY19, it has been on an improving ROE trajectory and has now established itself as an industry leader in terms of growth, asset quality, and return ratio metrics. In FY24, the bank achieved an ROA of 2.3% and an ROE of 18%, and we expect it to sustainably deliver superior, high double-digit ROE in the near future.

With a market share of approximately 6.5% in deposits and 7.3% in advances, along with a growing franchise across retail and corporate banking, the bank remains well-positioned to capitalize on India's economic growth. Its ongoing investments in technology and customer-centric innovations are key to sustaining its competitive edge and ensuring a long runway for accelerated growth in the years to come.

Is *Quality* investing
rewarding in the long term ?

Historical Long Term Track Record

Quality Theme vs Value Theme vs Broader Equity Market Index



Growth Since Apr'05 to Dec'24 (% CAGR)

Since Inception of Nifty 200 Quality 30 TRI

Nifty 200 Quality 30 TRI **18.6%**

Nifty200 Value 30 TRI **16.7%**

Nifty 500 TRI (Broader Market) **15.0%**



Source: MFIE and internal research of WhiteOak Capital. For information purpose only. Returns upto 1 year are absolute and more than 1 year are CAGR. **Past performance may or may not be sustained in future and is not a guarantee of any future returns. Index performance does not signify scheme performance.** Data as on 31st December 2024. Broader Market is represented by Nifty 500 TRI in above table. Data is from 1st April 2005 (i.e. the base date of both the factor indices mentioned above).

Market Cap Wise Performance of Various Indices

Trailing % CAGR (As on 31st December 2024)



Index Name	3 Year	5 Year	7 year	10 year	12 year	15 year	18 year	Since 1-Apr-05
Nifty 500 TRI	15.4	19.0	14.3	13.9	15.1	12.8	12.5	15.0
Nifty 200 TRI	14.5	17.7	13.9	13.4	14.6	12.5	12.3	14.7
Nifty200 Value 30 TRI	35.7	30.9	16.2	14.4	14.9	13.7	16.1	16.7
Nifty 200 Quality 30 TRI	12.9	18.1	14.9	13.5	16.1	15.8	16.5	18.6

Nifty 200 Quality 30 TRI has delivered reasonable performance over Medium to Long Run

Data Source : MFIE and Internal Research. Performance for understanding purpose only. **Past performance may or may not be sustained in future and is not a guarantee of any future returns. Index performance does not signify scheme performance.** Broader Market is represented by Nifty 500 TRI in above table. Data is from 1st April 2005 (i.e. the base date of both the factor indices mentioned above).

Rolling Return Analysis on Daily Basis of Various Indices (As on 31st December 2024)

Rolling Return Period -->	5 Years			10 Years		
First Observation	01-Apr-10			01-Apr-15		
Indices Names -->	Nifty 500 TRI (Broader Market)	Nifty200 Value 30 TRI	Nifty 200 Quality 30 TRI	Nifty 500 TRI (Broader Market)	Nifty200 Value 30 TRI	Nifty 200 Quality 30 TRI
Minimum Return (%)	-1.4	-8.4	1.3	5.0	-0.9	10.7
Maximum Return (%)	23.4	37.6	36.6	18.2	20.4	25.5
Average Return (%)	12.5	13.3	17.4	12.6	11.8	17.0
Negative Observation	40	264	0	0	30	0
0 to 6% Return	431	473	44	7	305	0
6% to 10% Return	594	595	245	545	368	0
10% to 15% Return	1282	1031	698	1227	984	478
Above 15% Return	1314 71%	1298 64%	2674 92%	636 77%	728 71%	1937 100%
Total Observations	3661			2415		

Historically, Nifty 200 Quality 30 TRI has delivered **more than 10% return 100% of the times** for an investment horizon of 10 years.

Source: MFIE and Internal Research. Daily Rolling Return considered from 1-Apr-05 (i.e. the base date of both the factor indices mentioned above) to 31-Dec-24, first observation recorded on 1-Apr-10 (For 5 Years CAGR) and 1-Apr-2015 (For 10 Years CAGR). **Past performance may or may not be sustained in future and is not a guarantee of any future returns.** Above numbers are rounded-off to nearest decimal. Returns are in % CAGR. **Index performance does not signify scheme performance.** Broader Market is represented by Nifty 500 TRI in above table.

Long Term SIP Performance

10 Years Monthly SIP Rolling Returns (From 1-April-2005 to 31-December-2024)

% of times index delivered \geq 10% returns

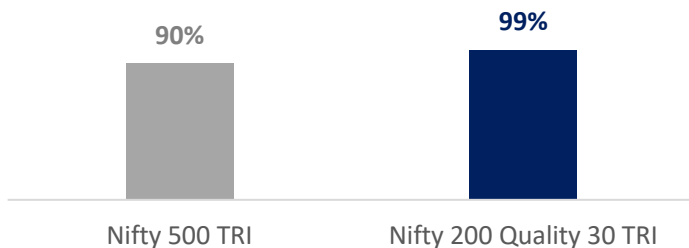

% of times index delivered \geq 15% returns

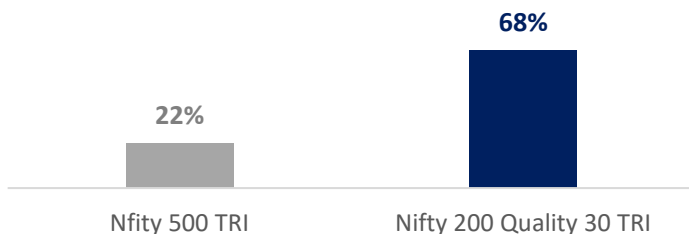

Index Name →	Nifty 500 TRI (Broader Market)	Nifty200 Value 30 TRI	Nifty 200 Quality 30 TRI
Minimum Return	3.9%	-6.2%	8.8%
Maximum Return	18.4%	25.2%	23.3%
Average Return	13.2%	11.7%	16.4%
Median Return	13.3%	12.1%	16.3%
% Times Positive Return	100%	94%	100%
% Times more than 10% Return	90%	69%	99%
% Times more than 12% Return	69%	51%	97%
% Times more than 15% Return	22%	22%	68%

“Quality Factor Theme” can be a good investment option for the investors seeking to invest via long term SIP route

Source: MFIE. 10 Year Monthly Rolling Return considered from 01-April-05 (i.e. the base date of both the factor indices mentioned above) to 31-December-24, first observation recorded on 01-Apr-15. **Past performance may or may not be sustained in future and is not a guarantee of any future returns. Index performance does not signify scheme performance.** Returns are in % XIRR. Numbers are rounded off to nearest decimal. Broader Market is represented by Nifty 500 TRI in above table.

How has the *Quality Factor* theme performed in recent years?

Winners Rotate

Yearly Style/Factor Leadership



^Part 2005	2006	2007	2008	2009	2010	2011	2012	2013	2014	2015	2016	2017	2018	2019	2020	2021	2022	2023	2024
Low Volatility 52.6	Momentum 44.2	Momentum 100.8	Low Volatility -42.3	Quality 131.0	Value 34.5	Quality -10.1	Value 45.6	Quality 19.6	Value 53.7	Alpha 19.2	Value 24.1	Alpha 62.9	Quality 8.9	Alpha 10.8	Quality 26.3	Alpha 56.2	Value 25.2	Value 62.8	Alpha 27.3
Momentum 41.8	Alpha 43.9	Alpha 91.8	Value -48.5	Value 123.4	Quality 28.4	Low Volatility -12.0	Momentum 38.8	Alpha 16.1	Momentum 49.6	Momentum 10.8	Momentum 9.6	Momentum 57.5	Low Volatility 7.4	Momentum 10.6	Low Volatility 24.3	Momentum 53.8	Nifty 500 4.2	Alpha 57.5	Value 22.5
Alpha 40.9	Low Volatility 43.3	Value 87.7	Quality -50.0	Low Volatility 92.9	Low Volatility 25.5	Momentum -16.1	Alpha 36.4	Momentum 12.9	Quality 40.5	Low Volatility 9.8	Alpha 9.3	Nifty 500 37.7	Momentum -1.7	Nifty 500 9.0	Alpha 23.1	Value 48.0	Low Volatility 2.0	Momentum 41.7	Momentum 21.2
Quality 40.9	Nifty 500 36.2	Nifty 500 64.6	Nifty 500 -56.5	Nifty 500 91.0	Momentum 19.8	Alpha -18.6	Nifty 500 33.5	Low Volatility 6.6	Alpha 40.4	Quality 2.4	Nifty 500 5.1	Value 35.4	Nifty 500 -2.1	Quality 5.6	Momentum 20.0	Nifty 500 31.6	Quality -4.4	Low Volatility 31.9	Nifty 500 16.1
Nifty 500 38.5	Quality 31.9	Quality 50.5	Momentum -60.0	Alpha 70.3	Nifty 500 15.3	Nifty 500 -26.4	Low Volatility 32.1	Nifty 500 4.8	Nifty 500 39.3	Nifty 500 0.2	Low Volatility 3.1	Low Volatility 30.3	Alpha -7.5	Low Volatility 5.2	Nifty 500 17.9	Quality 26.2	Momentum -5.4	Quality 31.7	Quality 14.3
Value 28.9	Value 12.3	Low Volatility 31.5	Alpha -68.2	Momentum 69.3	Alpha 12.7	Value -33.9	Quality 31.4	Value -10.8	Low Volatility 36.8	Value -20.1	Quality 1.0	Quality 30.3	Value -18.5	Value -8.8	Value 4.0	Low Volatility 24.2	Alpha -8.8	Nifty 500 26.9	Low Volatility 12.3

Ordered by performance (best to worst) for each Calendar Year. Source: MFI Explorer, Internal Research. Value = Nifty 200 Value 30 TRI, Momentum = Nifty 200 Momentum 30 TRI, Quality = Nifty 200 Quality 30 Index, Alpha = Nifty 200 Alpha 30 TRI, Low Volatility = Nifty 100 Low Volatility 30 TRI. For Understanding purpose only. **Past performance may or may not be sustained in future and is not a guarantee of any future returns.** Data as of December 31, 2024. ^Part 2005 = From 1st April 2005 (i.e. the base date of most of the factor indices mentioned above).

Quality Factor v/s Value Factor

Two contrasting themes

	Quality Factor	Value Factor
Parameters/ Characteristics	High Return on Equity (ROE), High Return on Capital Employed (ROCE), Low Financial Leverage (Debt to Equity Ratio), ability to generate Free Cash Flow etc.	Low Price-to-Earnings (P/E), Price-to-Book (P/B), Price-to-Sales (P/S) ratios, High Dividend Yield etc.
Periods of Relative Outperformance	Greater resilience, particularly during periods of market uncertainty	During recovery phases when economic conditions stabilize

In general, over time, it has been observed that companies within the quality factor theme are financially sounder and exhibit greater resilience, particularly during periods of market uncertainty. In contrast, companies within the value factor theme tend to perform well during recovery phases when economic conditions stabilize.

For understanding purpose only. **Past performance may or may not be sustained in future and is not a guarantee of any future returns.** The above comments are based on what has been generally observed during various market and economic cycles under normal circumstances. However, a market cycle may coincide with various other global events such as geo-political tension etc. and hence, the performance or these factors may react differently than what has been observed under normal circumstances. Additionally, the eligibility criteria mentioned above are among the most commonly used parameters, but the list is not exhaustive. There may be many other criteria or parameters that can be used to define a particular factor.

Tug of War: Quality v/s Value

Look who is making a comeback

Calendar Year	Nifty 200 Quality 30 TRI	Nifty200 Value 30 TRI	Winner
CY 2006	31.9%	12.3%	Quality
CY 2007	50.5%	87.7%	Value
CY 2008	-50.0%	-48.5%	Value
CY 2009	131.0%	123.4%	Quality
CY 2010	28.4%	34.5%	Value
CY 2011	-10.1%	-33.9%	Quality
CY 2012	31.4%	45.6%	Value
CY 2013	19.6%	-10.8%	Quality
CY 2014	40.5%	53.7%	Value
CY 2015	2.4%	-20.1%	Quality
CY 2016	1.0%	24.1%	Value
CY 2017	30.3%	35.4%	Value
CY 2018	8.9%	-18.5%	Quality
CY 2019	5.6%	-8.8%	Quality
CY 2020	26.3%	4.0%	Quality
CY 2021	26.2%	48.0%	Value
CY 2022	-4.4%	25.2%	Value
CY 2023	31.7%	62.8%	Value
CY 2024	17.0%	28.2%	Value
Since Apr'05	18.6%	16.7%	Quality

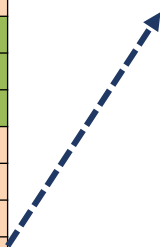

Monthly Return for Calendar Year 2024

During the Month	Nifty 200 Quality 30 TRI	Nifty200 Value 30 TRI	Winner
Jan'24	0.4%	7.6%	Value
Feb'24	1.1%	4.2%	
Mar'24	-0.3%	1.1%	
Apr'24	0.9%	10.4%	
May'24	4.0%	1.1%	Quality
Jun'24	6.6%	4.3%	
Jul'24	7.8%	6.6%	
Aug'24	2.6%	-0.3%	
Sep'24	2.3%	1.4%	
Oct'24	-8.6%	-9.1%	
Nov'24	0.0%	-0.8%	
Dec'24	-2.2%	-4.3%	

Source: Internal research of WhiteOak Capital, MFIE. Data from 1-Apr-2005 (i.e. the base date of both the factor indices mentioned above) and as on 31-December-2024. Returns less than 1 year are absolute and more than 1 year are CAGR. **Past performance may or may not be sustained in future and is not a guarantee of any future returns. Index performance does not signify scheme performance.**



Presenting,

WhiteOak Capital

Quality Equity Fund

(An open ended equity scheme following Quality Factor theme)

- WhiteOak Capital Quality Equity Fund is an **Actively Managed** scheme
- Scheme will invest predominantly in **Quality Factor Theme stocks**
- Quality theme refers to businesses that demonstrate strong fundamentals such as **return on equity (ROE)**, **return on capital employed (ROCE)**, **financial leverage (Debt/Equity Ratio)**, **free cash flow (FCF)** and has the ability to generate reasonable returns on incremental capital, and good corporate governance. Along with strong fundamentals, they also typically possess sustainable competitive advantages.
- Scheme aims to construct a diversified portfolio of predominantly quality factor theme stocks **across various sectors and industries**
- Scheme aims to select stock **across market capitalization**



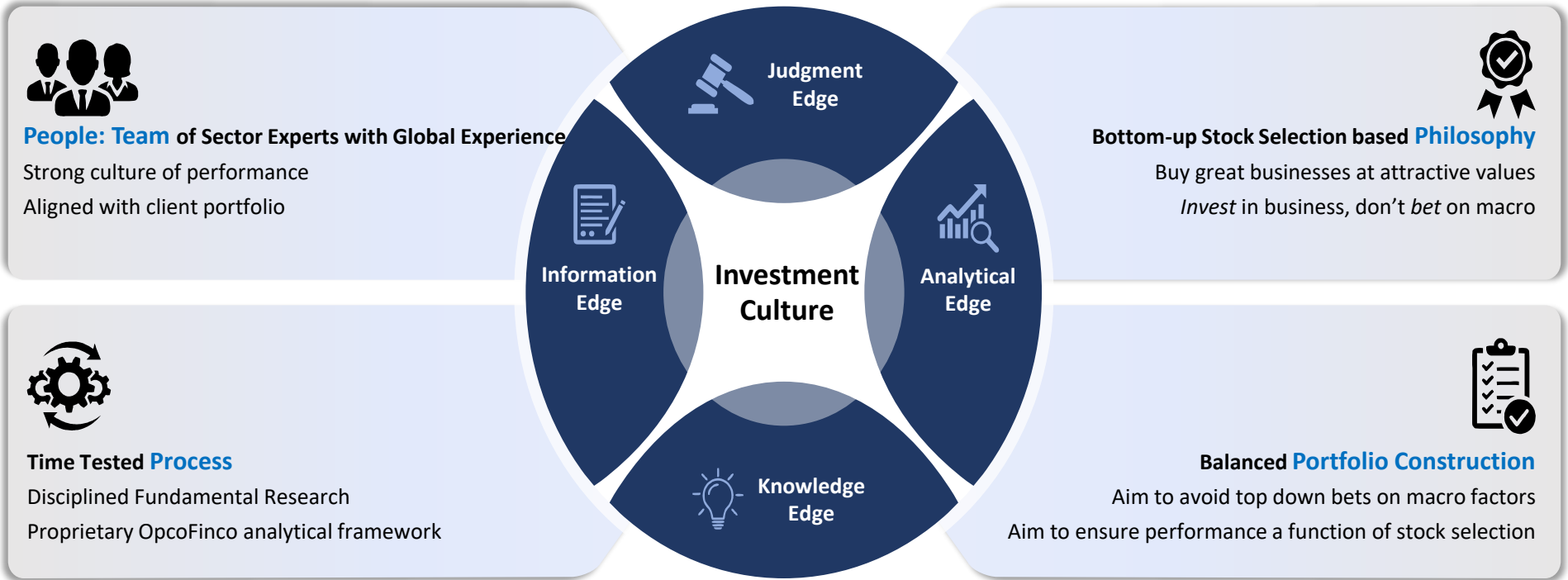

At WhiteOak we believe, “Outsized returns can be earned over time by investing in **Great Businesses at Attractive Valuations**”

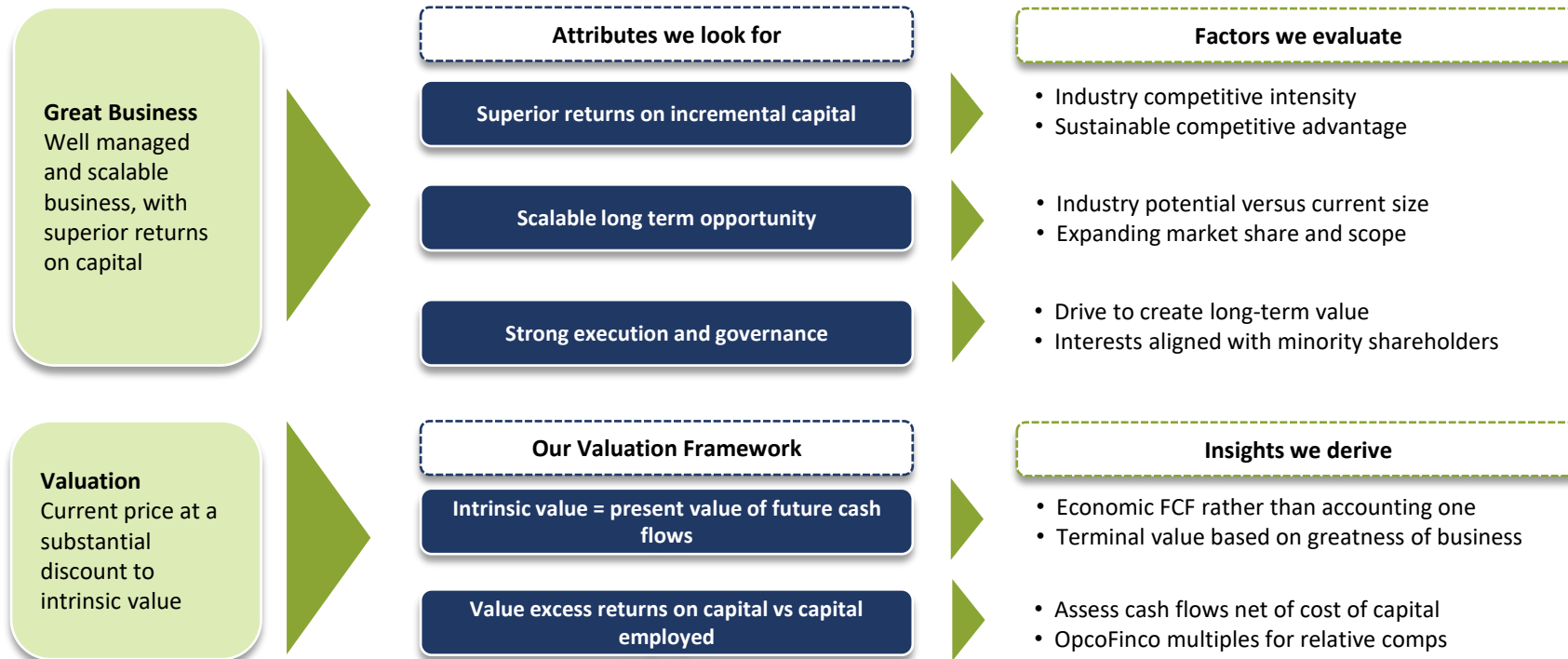

$$Value\ of\ a\ business = \frac{CF}{r - g}$$

Unique Process to Evaluate Relative Valuation

OpcoFinco Analytical Framework

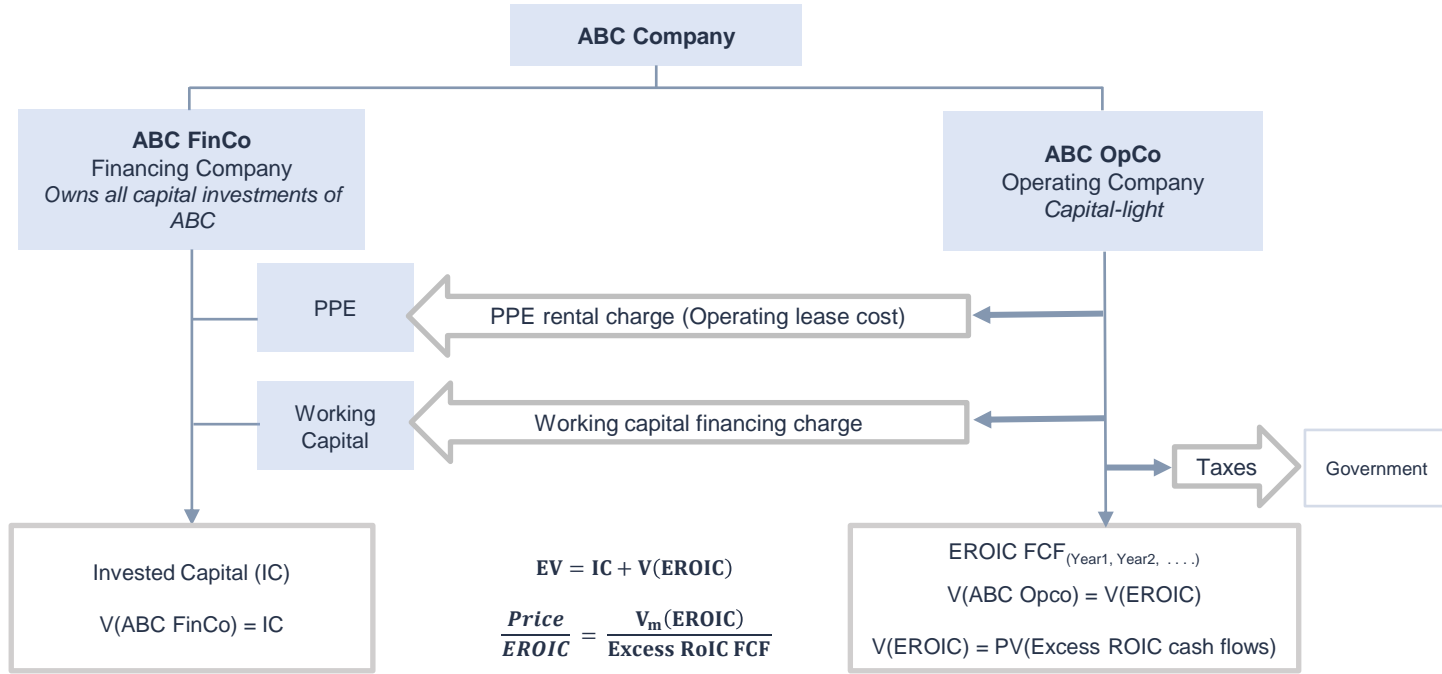

Proprietary OpcoFinco Analytical Framework is honed over many years

Abbreviations: PPE - Plant Property & Equipment, EROIC - Excess Return on Invested Capital, V(ABC FinCo) – Value of ABC FinCo, V(ABC OpCo) – Value of ABC OpCo, PV – Present Value
 Excess Return on Invested Capital – Return earned after subtracting the cost of capital

A Large & Experienced Analyst Team

Covering large universe of heterogeneous businesses across sectors and market cap

Diversified Across Various Sectors

Aim to construct a diversified portfolio of predominantly quality factor theme stocks across various sectors and industries.

Market Cap Agnostic

Bottom-up approach of stock selection with no bias for market capitalization

High Active Share

Scheme endeavors to keep a High Active Share, which is one of the necessary ingredients for potential alpha generation

Structure & Key Terms

Scheme Name / Category	WhiteOak Capital Quality Equity Fund
NFO Period	From 8 th January 2025 to 22 nd January 2025
Type of Scheme	An open ended equity scheme following Quality Factor theme.
Investment Objective	The objective of the Scheme is to provide long term capital appreciation by constructing a diversified investment portfolio based on the quality factor theme to provide investors with exposure to companies having strong fundamentals and sustainable competitive advantages, i.e., companies which exhibit long term stability as they may lead to more predictable returns, less volatility, strong management and sustainable growth. There is no assurance that the investment objective of the Scheme will be achieved.
Asset Allocation Pattern	Equity & Equity related Instruments of companies following Quality Factor theme: 80% - 100% Equity & Equity related Instruments of companies other than above: 0% - 20% Debt Securities and Money Market Instruments: 0% - 20% Units issued by REITs and InvITs: 0% - 10% Please refer to the Scheme Information Document for detailed asset allocation.
Plans	Regular Plan & Direct Plan
Options	Growth Option
Minimum Application Amount/ Swich-in	For Lumpsum Purchase: Minimum of Rs. 500/- and in multiples of Re. 1/- thereafter For SIP Purchase: Rs. 100/- for Weekly, Fortnightly & Monthly Frequency, Rs. 500/- for Quarterly SIP (and in multiples of Re. 1/- thereafter), Min. SIP installments: For weekly, Fortnightly, Monthly installments- 6, For Quarterly installments- 4
Load Structure	Entry Load: Nil. Exit Load: In respect of each purchase / switch-in of Units, an Exit Load of 1.00% is payable if Units are redeemed/ switched-out within 1 month from the date of allotment. No Exit Load is payable if Units are redeemed / switched-out after 1 month from the date of allotment.
Fund Manager	Mr. Ramesh Mantri (Equity), Ms. Trupti Agarwal (Assistant FM, Equity), Mr. Dheeresh Pathak (Assistant FM, Equity) & Mr. Piyush Baranwal (Debt)
Benchmark Index	BSE Quality TRI

Product Label, Risk-o-Meter and Disclaimer

WhiteOak Capital Quality Equity Fund (An open ended equity scheme following Quality Factor theme) is suitable for investors who are seeking*:

- Long Term Capital Appreciation
- Investment predominantly in equity & equity related instruments of Quality Factor theme

***Investors should consult their financial advisers if in doubt about whether the product is suitable for them.**

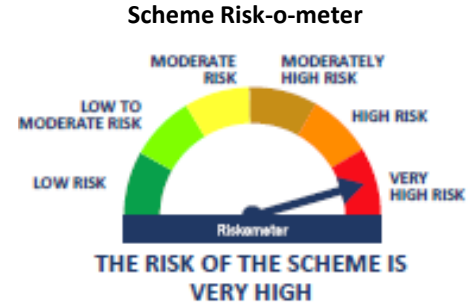

The product labelling assigned during the NFO is based on internal assessment of the Scheme characteristics or model portfolio and the same may vary post NFO when the actual investments are made. The AMC will evaluate the Risk-o-Meter on a monthly basis and shall disclose the same along with the portfolio disclosure.

While reasonable endeavors have been made to present reliable data in the Presentation, but WhiteOak Capital Asset Management Limited does not guarantee the accuracy or completeness of the data in the Presentation. WhiteOak Capital Asset Management Limited or any of its connected persons including its subsidiaries or associates or partners or employees shall not be in any way responsible for any loss or damage that may arise to any person from any inadvertent error in the information contained, views and opinions expressed in this Presentation. Past performance should not be taken as an indication or guarantee of future performance, and no representation or warranty, express or implied, is made regarding future performance. Information, opinions and estimates contained in this Presentation reflect a judgment of its original date of publication by WhiteOak Capital Asset Management Limited and are subject to change without notice. This Presentation is not directed or intended for distribution to, or use by, any person or entity who is a citizen or resident of or located in any locality, state, country or other jurisdiction, where such distribution, publication, availability or use would be contrary to local law, regulation or which would subject WhiteOak Capital Asset Management Limited and its affiliates to any registration or licensing requirement within such jurisdiction. The product described herein may or may not be eligible for sale in all jurisdictions or to certain category of investors. Persons in whose possession this Report/Presentation may come are required to inform themselves of and to observe such restrictions. Before making any investments, the readers are advised to seek independent professional advice, verify the contents in order to arrive at an informed investment decision.



mf.whiteoakamc.com



1800 266 3060



C/567/1/25



Annexure

Key Sectoral and Market Cap Indices Performance (%)

January 2025 Update
(Data as on 31-December-2024)

Index Name	From 52 Week High	1 Year	2 Year	3 Year	5 Year	10 Year	15 Year
Nifty 50 TRI	-9.7	10.0	15.5	12.2	15.5	12.4	12.0
Nifty 100 TRI	-10.0	12.8	17.0	12.8	16.1	12.8	12.4
Nifty Midcap 150 TRI	-5.9	24.3	34.1	23.2	28.3	18.7	17.2
Nifty Smallcap 250 TRI	-4.6	27.0	37.6	22.7	30.7	16.6	14.9
Nifty 500 TRI	-8.5	16.1	21.4	15.4	19.0	13.9	12.8
Nifty Microcap 250 TRI	-5.2	34.5	50.0	35.2	43.5	22.8	19.6
Nifty200 Value 30 TRI	-13.6	22.5	41.2	35.7	30.9	14.4	13.6
Nifty 200 TRI	-9.2	14.6	19.5	14.5	17.7	13.4	12.5
Nifty 200 Quality 30 Index TRI	-11.2	14.3	22.7	12.9	18.1	13.5	15.8
Nifty India Defence TRI	-21.6	56.0	72.7	70.8	54.9	--	--
Nifty Energy TRI	-21.1	6.4	17.9	17.4	19.7	17.4	11.1
BSE Utilities TRI	-20.6	14.7	25.3	25.3	28.4	15.4	8.2
Nifty Oil & Gas TRI	-20.2	13.9	13.5	14.6	17.6	15.9	12.0
Nifty PSU Bank TRI	-18.2	15.2	23.9	38.9	21.9	5.1	5.7
Nifty PSE TRI	-18.0	23.3	49.9	38.6	28.1	14.1	8.9
Nifty Auto TRI	-17.3	23.4	35.5	28.9	23.8	11.8	15.5
Nifty Commodities TRI	-17.3	6.1	17.7	14.6	20.5	13.8	8.4
Nifty Metal TRI	-15.1	9.2	14.0	17.7	27.2	15.0	6.2
Nifty FMCG TRI	-14.1	1.5	15.2	16.8	15.5	12.7	16.5
Nifty Infrastructure TRI	-12.5	16.7	27.8	20.7	22.6	12.4	7.3
Nifty India Manufacturing TRI	-12.2	25.8	30.3	21.4	25.1	14.0	12.9
BSE Consumer Discretionary TRI	-10.9	24.5	32.1	20.2	22.4	15.3	14.9
NIFTY100 ESG TRI	-10.4	12.7	17.9	10.5	17.0	13.6	--
Nifty Private Bank TRI	-9.0	0.4	7.3	12.0	7.4	10.5	14.7
Nifty Realty TRI	-8.3	34.5	56.4	29.9	29.1	18.4	5.5
Nifty Financial Services TRI	-6.5	10.4	12.4	11.7	10.8	13.0	14.2
Nifty Bank TRI	-6.5	6.2	9.7	13.7	10.2	11.2	13.1
Nifty IT TRI	-5.8	24.2	25.3	5.9	24.9	16.7	16.4
Nifty Healthcare TRI	-0.1	41.0	37.5	19.4	26.2	10.6	14.8

Sorted basis on % change from 52 Week High Levels for Sectoral Indices

Source: MFIE and internal research of WhiteOak Capital. For information purpose only. Returns upto 1 year are absolute and more than 1 year are CAGR. The sector(s) mentioned in this slide do not constitute any recommendation and WhiteOak Capital Mutual Fund may or may not have any future position in this sector(s). WhiteOak Capital Mutual Fund/ WhiteOak Capital Asset Management Limited is not guaranteeing or assuring any returns on investments in the above mentioned sector(s). Before making any investments, the readers are advised to seek independent professional advice, verify the contents in order to arrive at an informed investment decision. Past performance may or may not be sustained in future and is not a guarantee of any future returns. Index performance does not signify scheme performance.

Key Sectoral and Market Cap Indices Performance (%)

January 2025 Update

(Data as on 31-December-2024)



Index Name	CY 2024	Since 18-Oct-21	Since 23-Mar-20	Since 31-Dec-20	Since 52 Week High									
						1 Month	3 Months	6 Months	1 Year	2 Years	3 Years	5 Years	10 year	15 year
Nifty 50 TRI	10.0	9.3	28.2	15.4	-9.7	-2.0	-8.2	-1.1	10.0	15.5	12.2	15.5	12.4	12.0
Nifty Next 50 TRI	28.1	14.9	32.3	21.2	-12.5	-3.7	-11.7	-4.5	28.1	27.7	18.1	20.1	15.0	14.6
Nifty 100 TRI	12.8	9.9	28.7	16.1	-10.0	-2.1	-8.8	-1.6	12.8	17.0	12.8	16.1	12.8	12.4
Nifty Midcap 150 TRI	24.3	19.5	41.5	29.0	-5.9	1.1	-5.2	1.8	24.3	34.1	23.2	28.3	18.7	17.2
Nifty Smallcap 250 TRI	27.0	20.5	46.2	31.8	-4.6	0.2	-3.5	4.1	27.0	37.6	22.7	30.7	16.6	14.9
Nifty 500 TRI	16.1	12.4	31.9	19.3	-8.5	-1.3	-7.6	-0.4	16.1	21.4	15.4	19.0	13.9	12.8
Nifty Microcap 250 TRI	34.5	30.7	63.7	44.8	-5.2	-0.3	-2.6	8.9	34.5	50.0	35.2	43.5	22.8	19.6
Nifty100 Equal Weight TRI	17.4	12.9	32.8	20.5	-12.2	-2.3	-11.3	-3.4	17.4	23.9	16.3	19.8	13.1	12.7
Nifty200 Value 30 TRI	22.5	27.7	47.8	38.7	-13.6	-4.1	-13.6	-6.8	22.5	41.2	35.7	30.9	14.4	13.6
Nifty 200 Quality 30 Index TRI	14.3	11.3	27.0	16.1	-11.2	-2.1	-10.6	1.2	14.3	22.7	12.9	18.1	13.5	15.8
Nifty 200 TRI	14.6	11.3	30.5	17.9	-9.2	-1.6	-8.1	-0.9	14.6	19.5	14.5	17.7	13.4	12.5
Nifty India Defence TRI	56.0	63.4	75.5	68.3	-21.6	-3.1	-2.4	-10.5	56.0	72.7	70.8	54.9	--	--
Nifty PSU Bank TRI	15.2	31.5	42.0	40.4	-18.2	-3.9	-3.2	-11.1	15.2	23.9	38.9	21.9	5.1	5.7
Nifty PSE TRI	23.3	30.2	42.3	40.1	-18.0	-5.6	-15.2	-9.8	23.3	49.9	38.6	28.1	14.1	8.9
Nifty Realty TRI	34.5	23.4	46.2	35.7	-8.3	3.1	-4.2	-4.5	34.5	56.4	29.9	29.1	18.4	5.5
Nifty Auto TRI	23.4	23.8	40.9	26.7	-17.3	-2.2	-15.5	-8.8	23.4	35.5	28.9	23.8	11.8	15.5
BSE Utilities TRI	14.7	19.9	40.2	35.3	-20.6	-6.4	-19.7	-12.3	14.7	25.3	25.3	28.4	15.4	8.2
Nifty India Manufacturing TRI	25.8	17.3	39.0	25.2	-12.2	-1.8	-11.4	-5.0	25.8	30.3	21.4	25.1	14.0	12.9
Nifty Infrastructure TRI	16.7	16.9	35.4	24.7	-12.5	-3.0	-11.5	-6.8	16.7	27.8	20.7	22.6	12.4	7.3
BSE Consumer Discretionary TRI	24.5	16.8	35.1	22.7	-10.9	0.0	-9.8	-0.3	24.5	32.1	20.2	22.4	15.3	14.9
Nifty Healthcare TRI	41.0	17.9	32.5	19.3	-0.1	5.7	1.4	19.1	41.0	37.5	19.4	26.2	10.6	14.8
Nifty Metal TRI	9.2	12.3	46.5	29.7	-15.1	-3.9	-14.9	-11.1	9.2	14.0	17.7	27.2	15.0	6.2
Nifty Energy TRI	6.4	12.9	33.0	22.3	-21.1	-5.9	-19.8	-15.0	6.4	17.9	17.4	19.7	17.4	11.1
Nifty FMCG TRI	1.5	12.2	22.8	15.7	-14.1	-1.9	-13.1	0.5	1.5	15.2	16.8	15.5	12.7	16.5
Nifty Oil & Gas TRI	13.9	10.2	31.1	19.9	-20.2	-3.1	-17.5	-11.6	13.9	13.5	14.6	17.6	15.9	12.0
Nifty Commodities TRI	6.1	10.2	34.6	22.5	-17.3	-4.6	-17.2	-11.7	6.1	17.7	14.6	20.5	13.8	8.4
Nifty Bank TRI	6.2	8.9	26.7	13.7	-6.5	-2.2	-4.0	-2.6	6.2	9.7	13.7	10.2	11.2	13.1
Nifty Private Bank TRI	0.4	6.6	24.3	10.1	-9.0	-2.1	-6.5	-4.6	0.4	7.3	12.0	7.4	10.5	14.7
Nifty Financial Services TRI	10.4	7.8	25.3	12.4	-6.5	-2.0	-3.9	0.7	10.4	12.4	11.7	10.8	13.0	14.2
NIFTY100 ESG TRI	12.7	8.5	29.2	15.6	-10.4	-1.9	-9.3	-0.8	12.7	17.9	10.5	17.0	13.6	--
Nifty IT TRI	24.2	7.8	35.3	17.8	-5.8	0.4	3.9	20.5	24.2	25.3	5.9	24.9	16.7	16.4

Source: MFIE and internal research of WhiteOak Capital. For information purpose only. Returns upto 1 year are absolute and more than 1 year are CAGR. The sector(s) mentioned in this slide do not constitute any recommendation and WhiteOak Capital Mutual Fund may or may not have any future position in this sector(s). WhiteOak Capital Mutual Fund/ WhiteOak Capital Asset Management Limited is not guaranteeing or assuring any returns on investments in the above mentioned sector(s). Before making any investments, the readers are advised to seek independent professional advice, verify the contents in order to arrive at an informed investment decision. Past performance may or may not be sustained in future and is not a guarantee of any future returns. Index performance does not signify scheme performance.

Key Sectoral and Market Cap Indices Calendar Year Wise (%) January 2025 Update (Data as on 31-December-2024)

Index Name	CY 2024	CY 2023	CY 2022	CY 2021	CY 2020	CY 2019	CY 2018	CY 2017	CY 2016	CY 2015	CY 2014	CY 2013	CY 2012	CY 2011	CY 2010	CY 2009	CY 2008	CY 2007
Nifty 50 TRI	10.0	21.4	5.7	25.6	16.1	13.5	4.6	30.4	4.4	-3.0	32.9	8.1	29.3	-23.9	19.2	77.6	-51.2	56.5
Nifty Next 50 TRI	28.1	27.3	1.0	30.9	15.9	1.6	-7.8	47.9	8.4	8.1	46.4	6.0	49.5	-31.2	18.9	130.5	-63.0	76.9
Nifty 100 TRI	12.8	21.3	5.0	26.5	16.0	11.8	2.6	33.0	5.0	-1.3	34.9	7.9	32.3	-25.0	19.3	84.9	-53.0	59.2
Nifty Midcap 150 TRI	24.3	44.7	3.9	48.2	25.5	0.6	-12.6	55.9	6.5	9.7	62.7	-1.3	46.4	-31.1	20.1	113.9	-64.8	77.8
Nifty Smallcap 250 TRI	27.0	49.2	-2.6	63.3	26.4	-7.3	-26.0	58.6	1.4	11.3	71.7	-6.4	40.2	-35.2	17.6	117.4	-68.5	96.9
Nifty 500 TRI	16.1	27.0	4.3	31.6	17.8	9.0	-2.1	37.8	5.1	0.2	39.3	4.8	33.3	-26.5	15.3	91.0	-56.4	64.2
Nifty Microcap 250 TRI	34.5	67.5	9.7	77.9	38.2	-23.5	-27.0	75.8	3.8	25.9	105.7	-5.2	43.7	-40.8	13.2	121.6	-74.8	113.2
Nifty100 Equal Weight TRI	17.4	30.8	2.4	34.0	17.4	3.6	-8.4	36.2	7.4	0.2	42.5	4.7	39.6	-29.2	17.8	120.9	-53.4	57.8
Nifty200 Value 30 TRI	22.5	63.0	25.3	48.0	4.0	-8.8	-18.4	35.5	24.1	-20.1	53.7	-10.8	45.3	-34.0	34.5	123.4	-48.4	87.2
Nifty 200 Quality 30 Index TRI	14.3	31.8	-4.4	26.2	26.2	5.6	8.8	30.4	1.0	2.4	40.5	19.6	31.2	-10.1	28.4	131.0	-49.9	50.2
Nifty 200 TRI	14.6	24.7	4.9	28.9	16.8	10.0	0.3	35.3	5.1	-0.8	37.3	5.9	33.4	-26.1	15.6	88.8	-56.0	65.2
Nifty India Defence TRI	56.0	91.4	67.0	60.9	11.4	2.3	--	--	--	--	--	--	--	--	--	--	--	--
Nifty Healthcare TRI	41.0	34.1	-10.1	19.1	57.7	-5.9	-5.2	-1.9	-13.2	12.9	47.6	21.9	33.7	-11.8	36.6	71.4	-29.4	18.8
Nifty Realty TRI	34.5	82.2	-10.6	54.7	5.7	29.3	-32.5	111.0	-3.5	-14.4	10.8	-33.6	53.3	-51.4	-25.3	71.4	-82.5	73.3
Nifty India Manufacturing TRI	25.8	35.0	5.3	37.4	24.7	-3.4	-14.9	32.8	7.6	3.1	47.0	7.0	29.2	-31.0	18.7	158.2	-61.0	55.6
BSE Consumer Discretionary TRI	24.5	40.2	-0.6	30.7	21.4	-0.7	-15.1	55.8	5.8	8.9	55.6	-1.9	41.4	-21.6	13.7	109.2	-65.9	40.2
Nifty IT TRI	24.2	26.4	-24.5	62.4	57.9	11.0	26.0	14.6	-5.3	1.6	20.1	60.2	-0.2	-17.1	30.8	167.6	-54.1	-11.0
Nifty Auto TRI	23.4	48.9	16.6	20.3	13.0	-9.4	-22.2	32.7	11.7	0.3	58.2	10.7	44.3	-17.9	37.5	197.7	-53.9	6.5
Nifty PSE TRI	23.3	82.5	18.4	44.5	-10.3	-1.4	-17.7	21.1	21.6	-9.3	37.8	-5.9	11.8	-30.2	-5.5	79.7	-49.0	86.3
Nifty Infrastructure TRI	16.7	40.2	7.5	37.8	14.3	4.5	-10.9	36.2	-0.9	-7.6	24.2	-2.8	22.9	-38.1	-3.3	40.9	-56.8	96.1
Nifty PSU Bank TRI	15.2	33.4	74.9	44.8	-30.5	-18.3	-16.5	25.0	5.1	-32.0	69.9	-28.7	43.2	-41.0	36.5	77.5	-39.2	72.2
BSE Utilities TRI	14.7	37.1	25.2	70.4	4.2	-4.4	-12.9	32.6	12.1	-2.4	23.1	-11.7	12.2	-33.5	-4.9	73.8	-55.5	155.4
Nifty Oil & Gas TRI	13.9	13.1	16.9	37.2	9.1	14.6	-7.5	43.1	26.2	1.8	26.3	3.7	13.5	-24.4	11.1	77.9	-50.6	109.7
NIFTY100 ESG TRI	12.7	23.4	-3.0	32.3	22.9	12.3	5.2	33.4	4.6	-0.9	34.0	10.9	35.3	--	--	--	--	--
Nifty Financial Services TRI	10.4	14.4	10.5	14.6	4.7	26.4	11.3	42.8	6.2	-4.5	59.1	-6.1	53.8	-28.4	31.3	91.3	-54.5	84.4
Nifty Metal TRI	9.2	19.2	25.4	73.4	18.0	-9.6	-16.7	54.1	48.4	-29.4	8.4	--	--	--	--	--	--	--
Nifty Energy TRI	6.4	30.7	16.5	38.4	9.5	13.3	2.8	42.1	21.6	1.1	10.1	1.9	15.4	-28.3	4.8	63.5	-47.3	99.6
Nifty Bank TRI	6.2	13.3	22.2	13.9	-2.8	18.9	6.7	41.5	8.5	-9.0	66.2	-7.7	58.1	-31.8	32.0	83.5	-48.4	65.8
Nifty Commodities TRI	6.1	30.7	8.7	49.8	12.6	2.1	-13.5	38.4	27.4	-7.5	18.6	-6.7	--	--	--	--	--	--
Nifty FMCG TRI	1.5	30.9	20.1	12.4	14.7	0.1	15.2	31.3	4.6	1.4	19.6	13.3	50.4	10.2	32.9	44.4	-17.8	25.0
Nifty Private Bank TRI	0.4	14.7	22.0	4.9	-2.9	16.8	8.6	41.8	8.5	-2.4	69.5	-2.0	68.6	-24.8	36.8	104.6	-56.5	93.1

Source: MFIE and internal research of WhiteOak Capital. For information purpose only. Returns upto 1 year are absolute and more than 1 year are CAGR. The sector(s) mentioned in this slide do not constitute any recommendation and WhiteOak Capital Mutual Fund may or may not have any future position in this sector(s). WhiteOak Capital Mutual Fund/ WhiteOak Capital Asset Management Limited is not guaranteeing or assuring any returns on investments in the above mentioned sector(s). Before making any investments, the readers are advised to seek independent professional advice, verify the contents in order to arrive at an informed investment decision. **Past performance may or may not be sustained in future and is not a guarantee of any future returns. Index performance does not signify scheme performance.**



Corporate Profile of WhiteOak Capital Group



Expertise and prior Experience only in
Investment Management

- One of the few in the industry with DNA of investment management
- Group of Professionals led by an investment professional as 'Founder' to get SEBI license to set up an Asset Management Company (AMC)
- Core competence in domestic and global emerging equity markets



Founded by
Prashant Khemka
in June 2017



AUM
~US\$ 9.44 Bn
(~Rs. 79,818 Crore)



Offices

India, Singapore, Mauritius,
Switzerland, Spain, UK and Dubai



Prashant Khemka Founder

- 2000** Prashant joined **Goldman Sachs Asset Management (GSAM)** in the US Growth Equity Team
- 2004** Became **Senior PM and Co-Chair of the Investment Committee** on the **US Growth Equity team** which managed US\$25 bn
- 2006** Returned to Mumbai to start **GSAM India business**, where he served as **CIO and CEO / Co-CEO** until 2013
- 2013** Moved to Singapore as **CIO and Lead PM of both India and Global Emerging Markets**
- 2017** **Founded WhiteOak Capital Group**

Extensive investing record across India, Global Emerging Market (GEM) and the US

WhiteOak Capital Group – Key Milestones

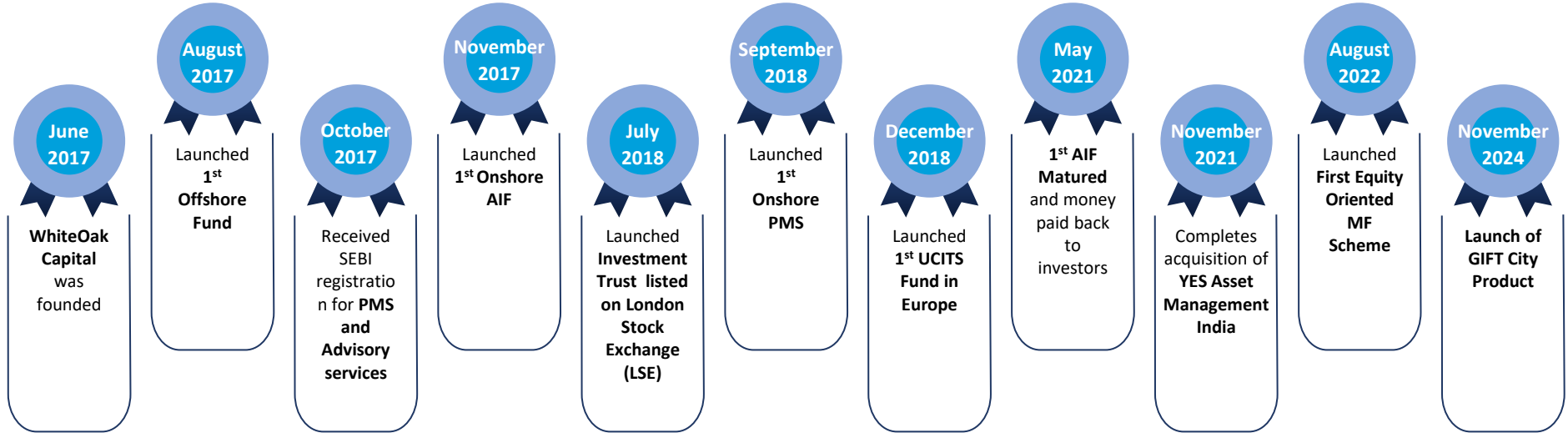

WhiteOak Capital AMC

Domestic Mutual Fund

- Launched first Equity NFO in August 2022, total AUM: **~US\$ 1,855 Mn**
- Performance backed by expanding product suite
- Empanelment with large wealth distributors, national retail distributors and banks
- One of the fastest scale-up for a domestic mutual fund, crossing Rs 100bn in AUM recently

Discretionary Portfolio Management Services (PMS)

- PMS business transferred to AMC in April 2024
- Launched in Sep 2018; amongst the top 5 PMS by AUM, total AUM: **~US\$ 684 Mn**
- Flagship strategy amongst top performers in peer group

White Oak Capital Management Consultants LLP

WhiteOak Capital LLP

Alternative Investment Funds (AIF) outside the AMC, group entity WhiteOak LLP, has AUM of **~US\$ 419mn** across four AIFs

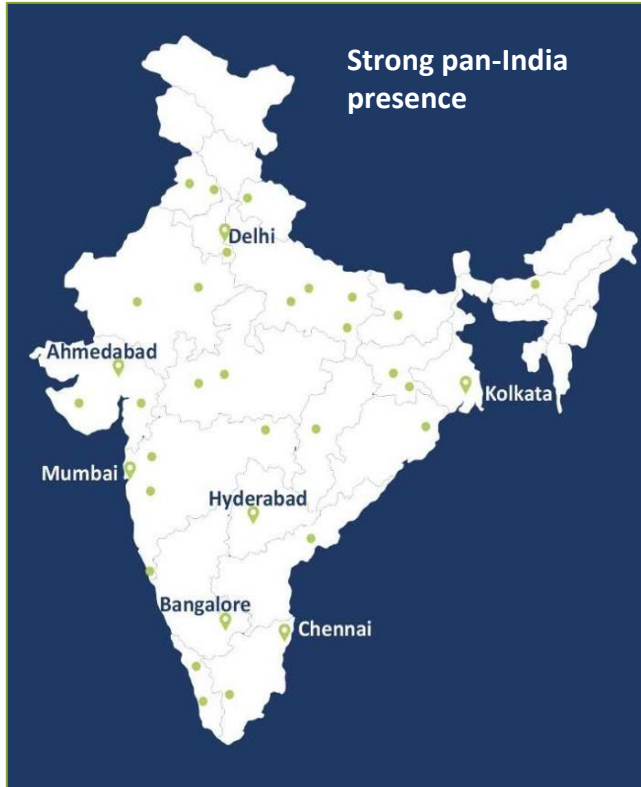

Robust Distribution

- Empanelment with all major private and MNC banks
- 35 large wealth distributors
- ~70 Retail National Distributors
- ~20,000+ Mutual Fund Distributors
- ~310 Registered Investment Advisors
- 49 branches across 20 states

Granular Client Base¹

- Number of unique investors: **~582k**
- Number of unique investors outside metros: **~205k**
- Number of live SIPs: **~372k**
- Number of live SIPs outside metros: **~153k**

Evolution of Retail AMC Business



AUM of Retail AMC Business

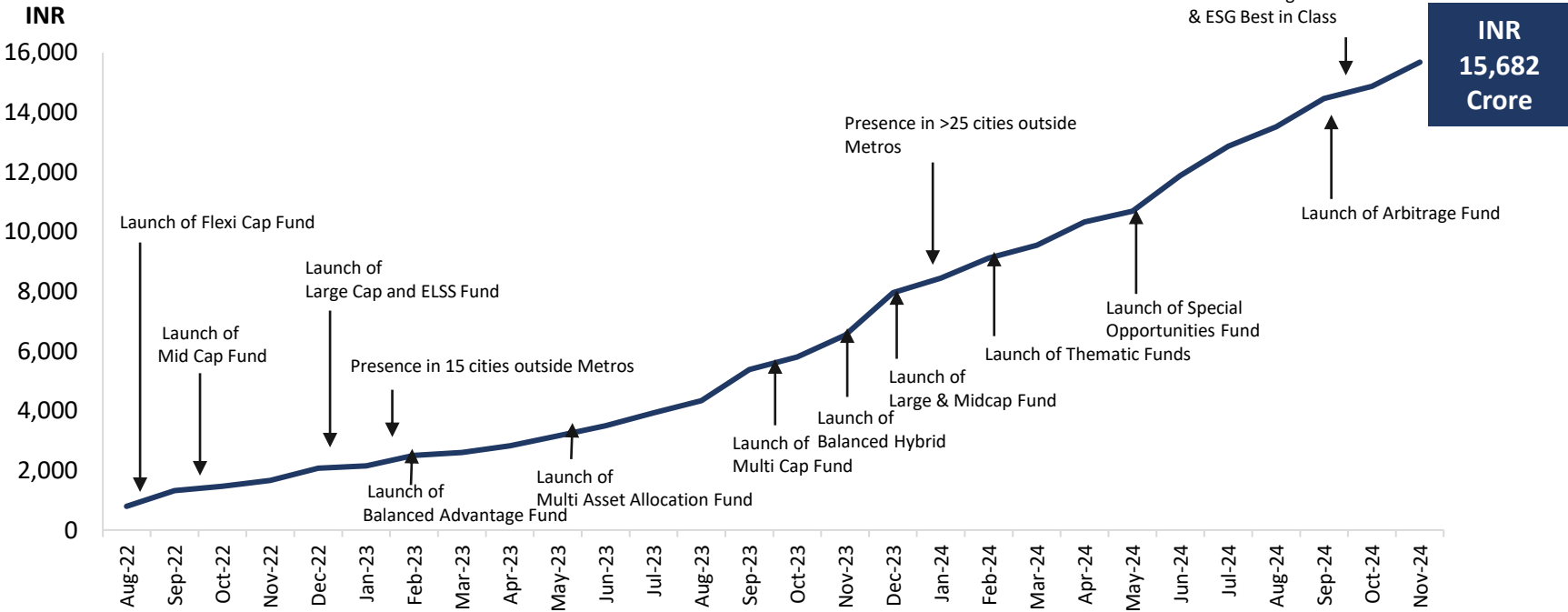

Source: WhiteOak Capital. AUM data as on 29th November 2024.

Assets Under Management or Advisory of the WhiteOak Capital Group

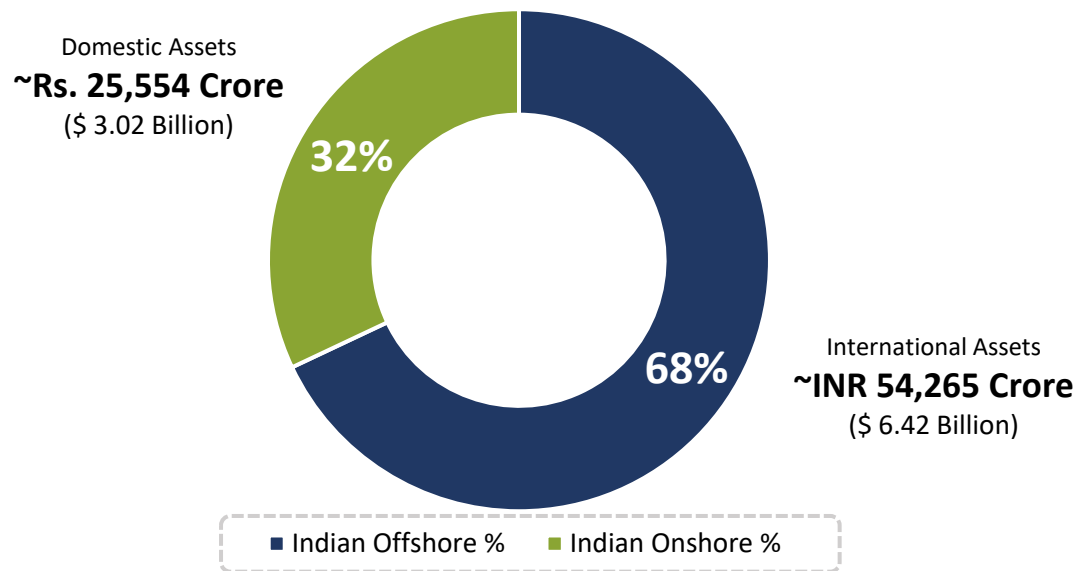

Total AUM of
~Rs. 79,818 Crore
~(\$ 9.44 Billion)